

TF 125 (1:10)

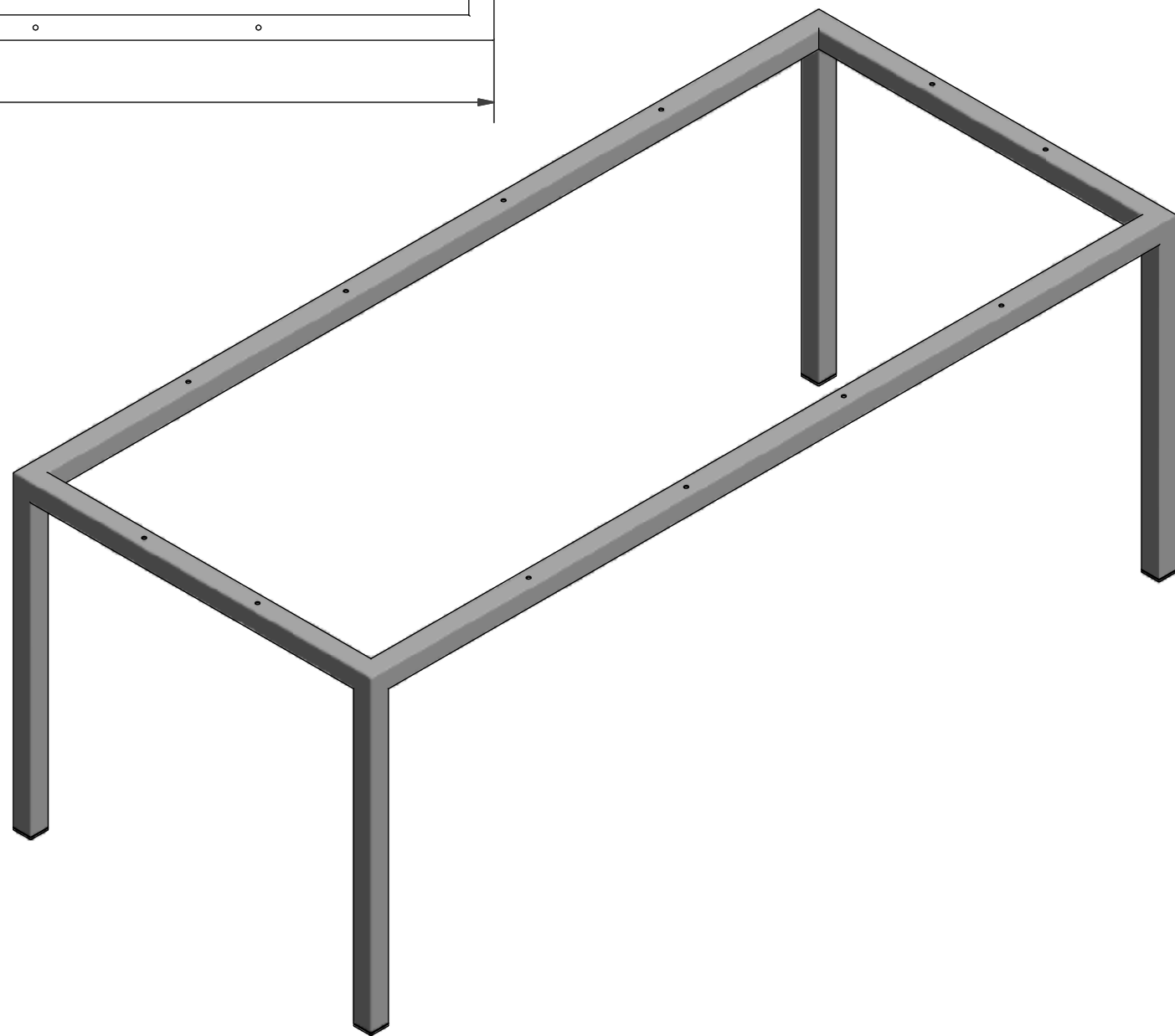
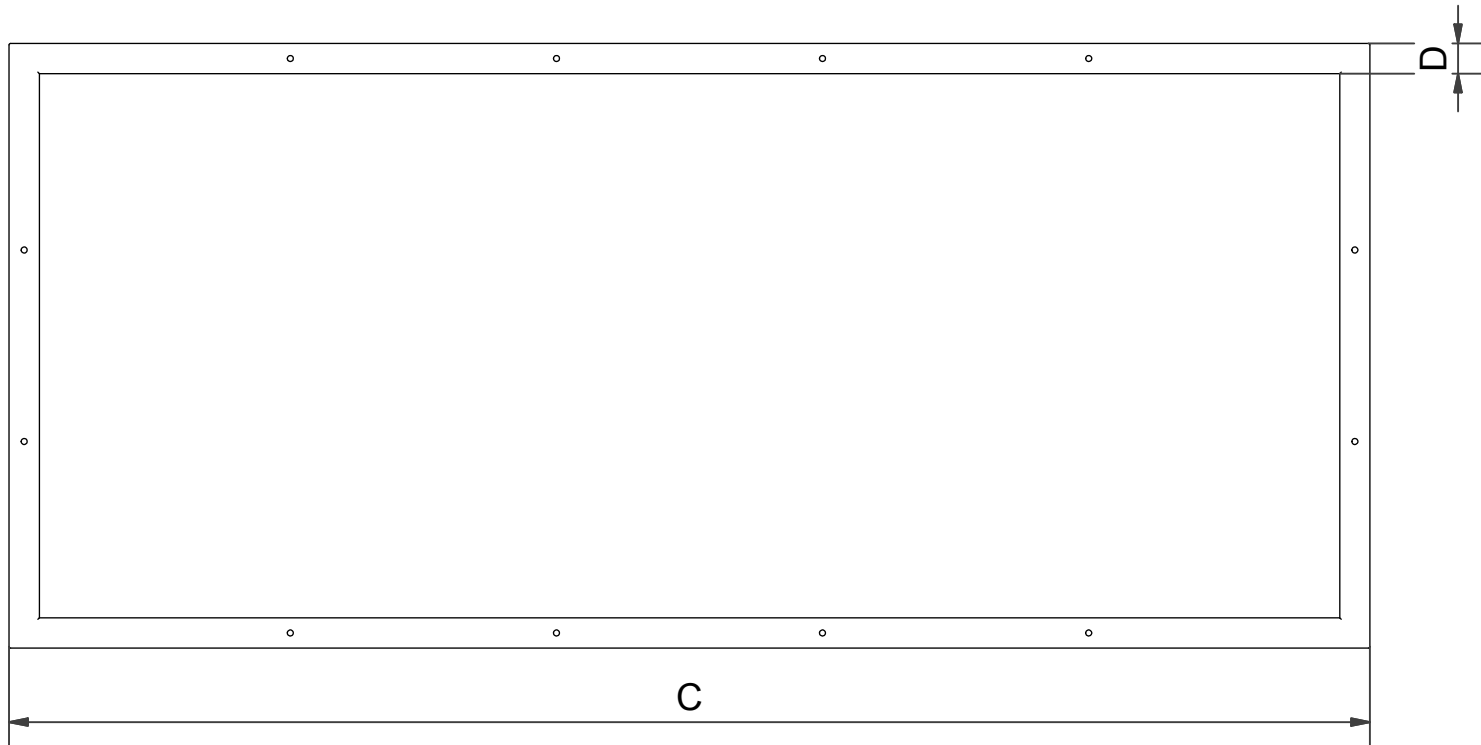
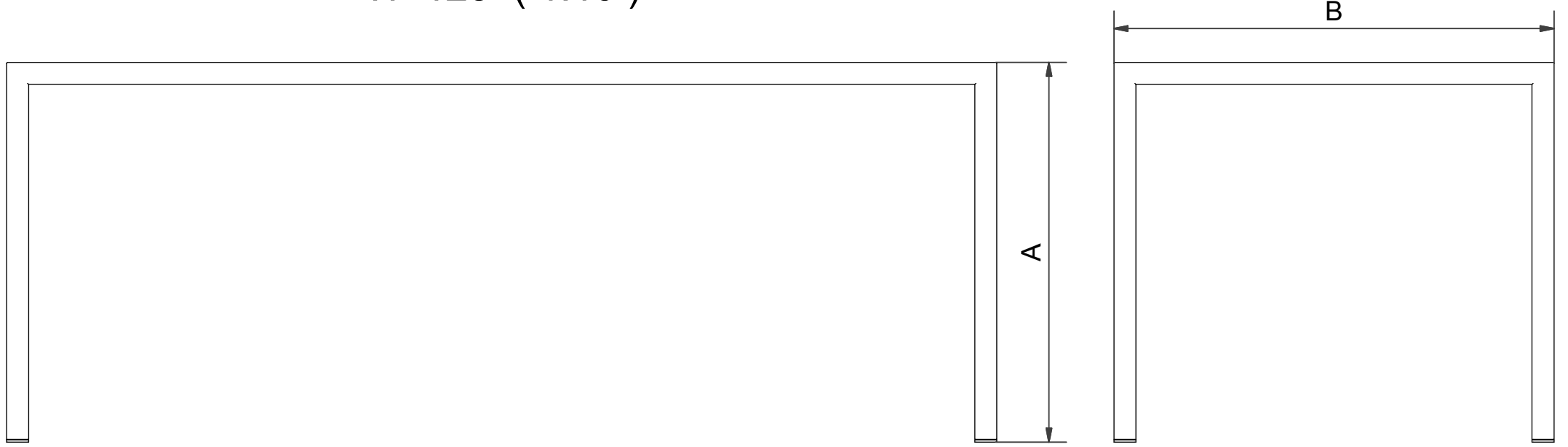

Masseingabe

A=.....

B=

C=

D=.....